

# PLOBERGER

SOLUTIONS FOR PROFESSIONALS

## Neu: Schrauben Gewerbepackungen



### Optimax:

Die neue Faltschachtel bei Ploberger!



[shop.ploberger.net](http://shop.ploberger.net)

# Optimax: Die neue H-PLUS Faltschachtel bei Ploberger

Ideal für Handwerk, Gewerbe und Industrie....

Viele Schraubenverpackungen sind zwar schön und gut, aber auch nicht wirklich praktisch, robust und umweltfreundlich. Wir von Ploberger produzieren unsere Verpackungen optimiert für die Anforderungen von Metall, Bau und Industrie, für die Verwendung in Werkstätten und auf Baustellen. Aufbewahrung sicher und fachgerecht.



**NEU**



# Verbindungselemente lagern mit System

Ob Schrauben, Normteile, Verbrauchsmaterialien, Werkzeuge oder Arbeitsschutz, Ploberger versorgt Sie nicht nur mit allen technischen Produkten, sondern auch mit den passenden Regalsystemen dazu. Wir übernehmen und optimieren gerne auch die Bewirtschaftung für Sie.



Barcode-Katalog



## E-Shop

Professionell, individuell und persönlich



Plo-Save  
Ausgabeautomat



Plo-Shelf  
Kanban-Regal



Plo-Scan  
Online-Scanner



Plo-Store  
Ausgabeschrank

# shop.ploberger.net

## Innensechskantschrauben



### Zylinderschrauben DIN 912 / ISO 4762 Stahl 8.8 vz

Zylinderschrauben DIN 912/ ISO 4762 Stahl 8.8; verzinkt; metrische Schraube aus Stahl mit Zylinderkopf und Innensechskant als Antrieb; VG: Vollgewinde, TG: Teilgewinde;

Dimension	b mm	d2 mm	s mm	k mm	t mm		Teile-Nr.
<b>M4</b>							
M4 x 8 VG	0,00	7,00	3	4,00	2,00	100	L-K41479
M4 x 10 VG	0,00	7,00	3	4,00	2,00	100	L-K41480
M4 x 12 VG	0,00	7,00	3	4,00	2,00	100	L-K41481
M4 x 16 VG	0,00	7,00	3	4,00	2,00	100	L-K41482
M4 x 20 VG	0,00	7,00	3	4,00	2,00	100	L-K41483
M4 x 25 VG	0,00	7,00	3	4,00	2,00	100	L-K41484
M4 x 30 TG	20,00	7,00	3	4,00	2,00	100	L-K41485
<b>M5</b>							
M5 x 12 VG	0,00	8,50	4	5,00	2,50	100	L-K41486
M5 x 16 VG	0,00	8,50	4	5,00	2,50	100	L-K41487
M5 x 20 VG	0,00	8,50	4	5,00	2,50	100	L-K41488
M5 x 25 VG	0,00	8,50	4	5,00	2,50	100	L-K41489
M5 x 30 TG	22,00	8,50	4	5,00	2,50	100	L-K41490
M5 x 40 TG	22,00	8,50	4	5,00	2,50	100	L-K41491
M5 x 50 TG	22,00	8,50	4	5,00	2,50	100	L-K41492
<b>M6</b>							
M6 x 10 VG	0,00	10,00	5	6,00	3,00	100	L-K41493
M6 x 12 VG	0,00	10,00	5	6,00	3,00	100	L-K41494
M6 x 16 VG	0,00	10,00	5	6,00	3,00	100	L-K41495
M6 x 20 VG	0,00	10,00	5	6,00	3,00	100	L-K41496
M6 x 25 VG	0,00	10,00	5	6,00	3,00	100	L-K41497
M6 x 30 VG	0,00	10,00	5	6,00	3,00	100	L-K41498
M6 x 35 TG	24,00	10,00	5	6,00	3,00	100	L-K41499
M6 x 40 TG	24,00	10,00	5	6,00	3,00	100	L-K41500
M6 x 45 TG	24,00	10,00	5	6,00	3,00	100	L-K41501
M6 x 50 TG	24,00	10,00	5	6,00	3,00	100	L-K41502
M6 x 60 TG	24,00	10,00	5	6,00	3,00	100	L-K41503
<b>M8</b>							
M8 x 12 VG	0,00	13,00	6	8,00	4,00	200	L-K41504
M8 x 16 VG	0,00	13,00	6	8,00	4,00	200	L-K41505
M8 x 20 VG	0,00	13,00	6	8,00	4,00	200	L-K41506
M8 x 25 VG	0,00	13,00	6	8,00	4,00	200	L-K41507
M8 x 30 VG	0,00	13,00	6	8,00	4,00	200	L-K41508
M8 x 35 VG	0,00	13,00	6	8,00	4,00	200	L-K41509
M8 x 40 TG	28,00	13,00	6	8,00	4,00	200	L-K41510
M8 x 45 TG	28,00	13,00	6	8,00	4,00	200	L-K41511
M8 x 50 TG	28,00	13,00	6	8,00	4,00	200	L-K41512
M8 x 60 TG	28,00	13,00	6	8,00	4,00	200	L-K41513
M8 x 70 TG	28,00	13,00	6	8,00	4,00	200	L-K41514
M8 x 80 TG	28,00	13,00	6	8,00	4,00	200	L-K41515
<b>M10</b>							
M10 x 12 VG	0,00	16,00	8	10,00	5,00	200	L-K41516
M10 x 16 VG	0,00	16,00	8	10,00	5,00	200	L-K41517
M10 x 20 VG	0,00	16,00	8	10,00	5,00	200	L-K41518
M10 x 25 VG	0,00	16,00	8	10,00	5,00	200	L-K41519
M10 x 30 VG	0,00	16,00	8	10,00	5,00	200	L-K41520
M10 x 35 VG	0,00	16,00	8	10,00	5,00	100	L-K41521
M10 x 40 VG	0,00	16,00	8	10,00	5,00	100	L-K41522
M10 x 50 TG	32,00	16,00	8	10,00	5,00	100	L-K41523
M10 x 60 TG	32,00	16,00	8	10,00	5,00	100	L-K41524
M10 x 80 TG	32,00	16,00	8	10,00	5,00	100	L-K41525
M10 x 100 TG	32,00	16,00	8	10,00	5,00	50	L-K41526
M10 x 120 TG	32,00	16,00	8	10,00	5,00	50	L-K41527
<b>M12</b>							
M12 x 20 VG	0,00	18,00	10	12,00	6,00	50	L-K41528
M12 x 25 VG	0,00	18,00	10	12,00	6,00	50	L-K41529
M12 x 30 VG	0,00	18,00	10	12,00	6,00	50	L-K41531
M12 x 35 VG	0,00	18,00	10	12,00	6,00	50	L-K41532
M12 x 40 VG	0,00	18,00	10	12,00	6,00	50	L-K41533
M12 x 50 VG	0,00	18,00	10	12,00	6,00	50	L-K41534
M12 x 60 TG	36,00	18,00	10	12,00	6,00	50	L-K41535
M12 x 80 TG	36,00	18,00	10	12,00	6,00	50	L-K41536
M12 x 100 TG	36,00	18,00	10	12,00	6,00	50	L-K41537
M12 x 120 TG	36,00	18,00	10	12,00	6,00	50	L-K41538

Aktuelle Preise und Aktionen: [shop.ploberger.net](http://shop.ploberger.net)

## Optimax: Die neue H-PLUS Faltschachtel bei Ploberger!

NEU



## Sechskantschrauben

### Sechskantschrauben DIN 933 / ISO 4017 Stahl 8.8 vz

Sechskantschrauben DIN 933 / ISO 4017 Stahl 8.8; mit Sechskantkopf; ohne Schaft; verzinkt; VG: Vollgewinde, TG: Teilgewinde;

Dimension	s mm	e mm	k mm		Teile-Nr.
<b>M4</b>					
M4 x 6 VG	7	7,66	2,80	200	L-K41568
M4 x 8 VG	7	7,66	2,80	200	L-K41569
M4 x 10 VG	7	7,66	2,80	200	L-K41570
M4 x 12 VG	7	7,66	2,80	200	L-K41571
M4 x 16 VG	7	7,66	2,80	200	L-K41572
M4 x 20 VG	7	7,66	2,80	200	L-K41573
M4 x 25 VG	7	7,66	2,80	200	L-K41574
M4 x 30 VG	7	7,66	2,80	200	L-K41576
<b>M5</b>					
M5 x 8 VG	8	8,79	3,50	200	L-K41578
M5 x 10 VG	8	8,79	3,50	200	L-K41579
M5 x 12 VG	8	8,79	3,50	200	L-K41580
M5 x 16 VG	8	8,79	3,50	200	L-K41581
M5 x 20 VG	8	8,79	3,50	200	L-K41582
M5 x 25 VG	8	8,79	3,50	200	L-K41583
M5 x 30 VG	8	8,79	3,50	200	L-K41584
M5 x 40 VG	8	8,79	3,50	200	L-K41585
<b>M6</b>					
M6 x 10 VG	10	11,05	4,00	200	L-K41586
M6 x 12 VG	10	11,05	4,00	200	L-K41587
M6 x 16 VG	10	11,05	4,00	200	L-K41588
M6 x 20 VG	10	11,05	4,00	200	L-K41589
M6 x 25 VG	10	11,05	4,00	200	L-K41590
M6 x 30 VG	10	11,05	4,00	200	L-K41591
M6 x 40 VG	10	11,05	4,00	200	L-K41592
M6 x 50 VG	10	11,05	4,00	200	L-K41593
<b>M8</b>					
M8 x 12 VG	13	14,38	5,30	200	L-K41594
M8 x 16 VG	13	14,38	5,30	200	L-K41595
M8 x 20 VG	13	14,38	5,30	200	L-K41596
M8 x 25 VG	13	14,38	5,30	200	L-K41597
M8 x 30 VG	13	14,38	5,30	200	L-K41598
M8 x 35 VG	13	14,38	5,30	200	L-K41599
M8 x 40 VG	13	14,38	5,30	200	L-K41600
M8 x 45 VG	13	14,38	5,30	200	L-K41601
M8 x 50 VG	13	14,38	5,30	200	L-K41602
M8 x 60 VG	13	14,38	5,30	200	L-K41603
<b>M16</b>					
M16 x 30 VG	24	26,75	10,00	50	L-K41627
M16 x 35 VG	24	26,75	10,00	50	L-K41628
M16 x 40 VG	24	26,75	10,00	50	L-K41629
M16 x 45 VG	24	26,75	10,00	50	L-K41630
M16 x 50 VG	24	26,75	10,00	25	L-K41631
M16 x 55 VG	24	26,75	10,00	25	L-K41632
M16 x 60 VG	24	26,75	10,00	25	L-K41633
M16 x 65 VG	24	26,75	10,00	25	L-K41634
M16 x 70 VG	24	26,75	10,00	25	L-K41635
M16 x 75 VG	24	26,75	10,00	25	L-K41636
M16 x 80 VG	24	26,75	10,00	25	L-K41637
M16 x 90 VG	24	26,75	10,00	25	L-K41638
M16 x 100 VG	24	26,75	10,00	25	L-K41639
<b>M20</b>					
M20 x 50 VG	30	33,53	12,50	25	L-K41640
M20 x 60 VG	30	33,53	12,50	25	L-K41641
M20 x 70 VG	30	33,53	12,50	25	L-K41642
M20 x 80 VG	30	33,53	12,50	25	L-K41643



# SECHSKANTSCHRAUBEN



## Sechskantschrauben ISO 4017 Stahl 8.8 vz

Metrische Schraube aus Stahl mit Sechskantkopf; VG=Vollgewinde; TG=Teilgewinde;

Dimension	s mm	e mm	k mm	 Teile-Nr.
<b>M10</b>				
M10 x 20 VG	16	17,77	6,40	200 L-K41604
M10 x 25 VG	16	17,77	6,40	200 L-K41605
M10 x 30 VG	16	17,77	6,40	200 L-K41606
M10 x 35 VG	16	17,77	6,40	100 L-K41607
M10 x 40 VG	16	17,77	6,40	100 L-K41608
M10 x 45 VG	16	17,77	6,40	100 L-K41609
M10 x 50 VG	16	17,77	6,40	100 L-K41610
M10 x 60 VG	16	17,77	6,40	100 L-K41611
M10 x 80 VG	16	17,77	6,40	100 L-K41612
<b>M12</b>				
M12 x 20 VG	18	20,03	7,50	100 L-K41613
M12 x 25 VG	18	20,03	7,50	100 L-K41614
M12 x 30 VG	18	20,03	7,50	50 L-K41615
M12 x 35 VG	18	20,03	7,50	50 L-K41616
M12 x 40 VG	18	20,03	7,50	50 L-K41617
M12 x 45 VG	18	20,03	7,50	50 L-K41618
M12 x 50 VG	18	20,03	7,50	50 L-K41619
M12 x 55 VG	18	20,03	7,50	50 L-K41620
M12 x 60 VG	18	20,03	7,50	50 L-K41621
M12 x 65 VG	18	20,03	7,50	50 L-K41622
M12 x 70 VG	18	20,03	7,50	50 L-K41623
M12 x 80 VG	18	20,03	7,50	50 L-K41624
M12 x 90 VG	18	20,03	7,50	50 L-K41625
M12 x 100 VG	18	20,03	7,50	50 L-K41626

## Aktuelle Preise und Aktionen: [shop.ploberger.net](http://shop.ploberger.net)

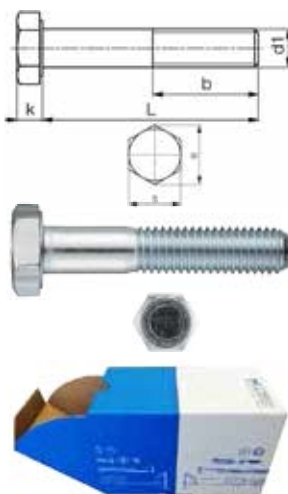

## Sechskantschrauben DIN 931 / ISO 4014 Stahl 8.8 vz

Sechskantschrauben DIN 931 / ISO 4014 Stahl 8.8; verzinkt; mit Schaft; VG: Vollgewinde, TG: Teilgewinde;

Dimension	b mm	s mm	e mm	k mm	 Teile-Nr.
<b>M8</b>					
M8 x 40 TG	22,00	13	14,38	5,30	200 L-K41539
M8 x 50 TG	22,00	13	14,38	5,30	200 L-K41540
M8 x 60 TG	22,00	13	14,38	5,30	200 L-K41541
M8 x 70 TG	22,00	13	14,38	5,30	100 L-K41542
M8 x 80 TG	22,00	13	14,38	5,30	100 L-K41543
<b>M16</b>					
M16 x 60 TG	38,00	24	26,75	10,00	25 L-K41561
M16 x 70 TG	38,00	24	26,75	10,00	25 L-K41562
M16 x 80 TG	38,00	24	26,75	10,00	25 L-K41563
M16 x 90 TG	38,00	24	26,75	10,00	25 L-K41564
M16 x 100 TG	38,00	24	26,75	10,00	25 L-K41565
M16 x 120 TG	38,00	24	26,75	10,00	25 L-K41566
M16 x 140 TG	44,00	24	26,75	10,00	25 L-K41567



## Sechskantschrauben ISO 4014 Stahl 8.8 vz

Metrische Schraube aus Stahl mit Sechskantkopf und Schaft; VG=Vollgewinde; TG=Teilgewinde;

Dimension	b mm	s mm	e mm	k mm	 Teile-Nr.
<b>M10</b>					
M10 x 40 TG	26,00	16	17,77	6,40	100 L-K41544
M10 x 50 TG	26,00	16	17,77	6,40	100 L-K41545
M10 x 60 TG	26,00	16	17,77	6,40	100 L-K41546
M10 x 70 TG	26,00	16	17,77	6,40	100 L-K41548
M10 x 80 TG	26,00	16	17,77	6,40	100 L-K41550
M10 x 90 TG	26,00	16	17,77	6,40	100 L-K41551
M10 x 100 TG	26,00	16	17,77	6,40	100 L-K41552
<b>M12</b>					
M12 x 50 TG	30,00	18	20,03	7,50	100 L-K41553
M12 x 60 TG	30,00	18	20,03	7,50	100 L-K41554
M12 x 70 TG	30,00	18	20,03	7,50	50 L-K41555
M12 x 80 TG	30,00	18	20,03	7,50	50 L-K41556
M12 x 90 TG	30,00	18	20,03	7,50	50 L-K41557
M12 x 100 TG	30,00	18	20,03	7,50	50 L-K41558
M12 x 120 TG	30,00	18	20,03	7,50	50 L-K41559
M12 x 140 TG	30,00	18	20,03	7,50	50 L-K41560

## Blechschauben, Bohrbefestiger

### Senk-Bohrschrauben KS-H DIN 7504P Stahl vz

Bohrschraube aus Stahl einsatzgehärtet mit Senkkopf und Kreuzschlitz H Phillips oder Innensechsrund (TX) als Antrieb; DIN 7504 P; verzinkt; VG: Vollgewinde, TG: Teilgewinde;

Dimension	Größe PH	d2 mm	k mm	m mm	Blechstärke mm	Teile-Nr.
4,80 mm						
4,8 x 32 VG	2	9,50	3,00	5,10	1,75 - 4,40	500 L-K41718
4,8 x 38 VG	2	9,50	3,00	5,10	1,75 - 4,40	500 L-K41719
4,8 x 50 VG	2	9,50	3,00	5,10	1,75 - 4,40	500 L-K41720

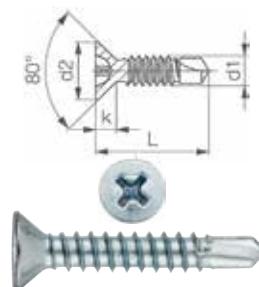

## Muttern, Gewindeeinsätze

### Sechskantmuttern DIN 934 / ISO 4032 Stahl 8 vz

Sechskantmuttern aus Stahl mit Innengewinde nach Norm; DIN 934; verzinkt; Stahl 8;

Dimension	s mm	e mm	m mm	Teile-Nr.
M3 / DIN 934, Standard, KP 500 Stk.	5,5	6,01	2,40	500 L-K41649
M4 / DIN 934, Standard, KP 500 Stk.	7	7,66	3,20	500 L-K41650
M5 / DIN 934, Standard, KP 500 Stk.	8	8,79	4,00	500 L-K41651
M6 / DIN 934, Standard, KP 500 Stk.	10	11,05	5,00	500 L-K41652
M8 / DIN 934, Standard, KP 100 Stk.	13	14,38	6,50	100 L-K41653
M10 / DIN 934, Standard, KP 100 Stk.	17	18,90	8,00	100 L-K41654
M12 / DIN 934, Standard, KP 100 Stk.	19	21,10	10,00	100 L-K41655
M14 / DIN 934, Standard, KP 100 Stk.	22	24,49	11,00	100 L-K41656
M16 / DIN 934, Standard, KP 100 Stk.	24	26,75	13,00	100 L-K41657
M20 / DIN 934, Standard, KP 25 Stk.	30	32,95	16,00	25 L-K41658
M24 / DIN 934, Standard, KP 25 Stk.	36	39,55	19,00	25 L-K41659
M30 / DIN 934, Standard, KP 5 Stk.	46	50,85	24,00	5 L-K41660

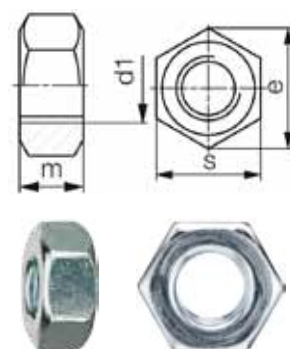

## Optimax: Die neue H-PLUS Faltschachtel bei Ploberger!



### Sechskant-Hutmuttern DIN 1587 Stahl 6 vz

Sechskant-Hutmuttern aus Stahl mit hoher Form; DIN 1587; Stahl 6; verzinkt;

d1 mm	s mm	e mm	h mm	t mm	Norm	Teile-Nr.
M6	10	11,05	12,00	8,29	DIN 1587	100 L-K41644
M8	13	14,38	15,00	11,35	DIN 1587	50 L-K41645
M10	17	18,90	18,00	13,35	DIN 1587	50 L-K41646
M12	19	21,10	22,00	16,35	DIN 1587	50 L-K41647
M16	24	26,75	28,00	21,42	DIN 1587	25 L-K41648



### Sicherungsmuttern DIN 985 / ISO 10511 Stahl 8 vz

Sicherungsmuttern aus Stahl mit niedriger Form und Polyamideinlage; DIN 985; Stahl 8; verzinkt;

d1 mm	s mm	e mm	h mm	m mm	Teile-Nr.
M4	7	7,66	5,00	2,90	500 L-K41661
M5	8	8,79	5,00	3,20	500 L-K41662
M6	10	11,05	6,00	4,00	500 L-K41663
M8	13	14,38	8,00	5,50	500 L-K41664
M10	17	18,90	10,00	6,50	100 L-K41665
M12	19	21,10	12,00	8,00	100 L-K41666
M16	24	26,75	16,00	10,50	100 L-K41667

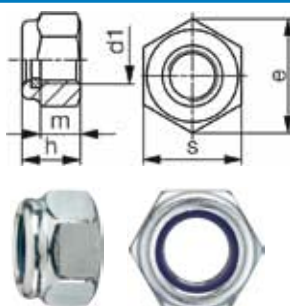

# SCHEIBEN, SICHERUNGSELEMENTE

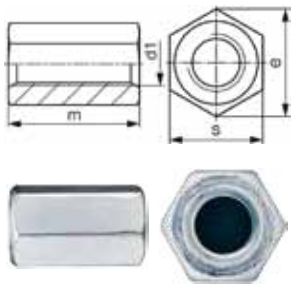

## Verlängerungsmuttern 6-kant Stahl vz

Verlängerungsmuttern 3 d hoch, sechskant aus Stahl; verzinkt;

d1 mm	s mm	e mm	m mm	 Teile-Nr.
M8	13	15,00	24,00	100 L-K41668
M10	17	19,60	30,00	100 L-K41669
M12	19	21,90	36,00	50 L-K41670
M16	24	27,70	48,00	25 L-K41671

## Scheiben, Sicherungselemente

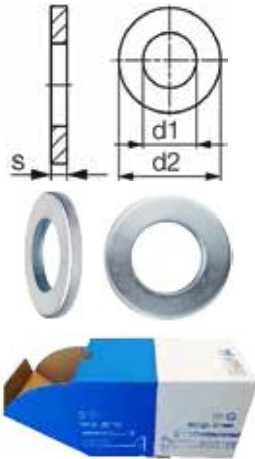

## Scheiben DIN 125A / ISO 7089 140HV Stahl vz

Scheiben DIN 125 A ISO 7089; ohne Fase; Stahl; verzinkt; Härte: 140HV;

für Schrauben	d1 mm	d2 mm	s mm	 Teile-Nr.
M3	3,2	7,00	0,5	1000 L-K41696
M4	4,3	9,00	0,8	1000 L-K41697
M5	5,3	10,00	1	1000 L-K41698
M6	6,4	12,00	1,6	1000 L-K41699
M8	8,4	16,00	1,6	1000 L-K41700
M10	10,5	20,00	2	500 L-K41701
M12	13	24,00	2,5	500 L-K41702
M14	15	28,00	2,5	500 L-K41703
M16	17	30,00	3	500 L-K41704
M20	21	37,00	3	200 L-K41705
M24	25	44,00	4	100 L-K41706
M30	31	56,00	4	50 L-K41707

## Optimax: Die neue H-PLUS Faltschachtel bei Ploberger!

**NEU**

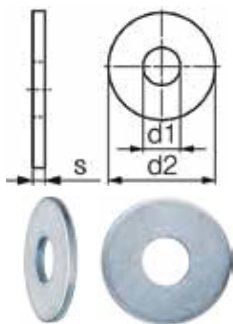

## Scheiben DIN 9021 / ISO 7093 140HV Stahl vz

Scheiben DIN 9021 ISO 7093; Stahl; verzinkt; Außen-Ø = 3 x Schrauben-Ø; Härte: 140HV;

für Schrauben	d1 mm	d2 mm	s mm	 Teile-Nr.
M6	6,4	18,00	1,6	200 L-K41692
M8	8,4	24,00	2	200 L-K41693
M10	10,5	30,00	2,5	200 L-K41694
M12	13	37,00	3	100 L-K41695

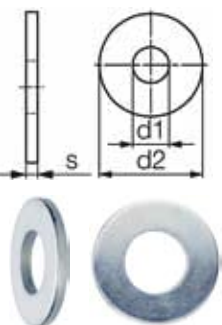

## Scheiben DIN 134 Stahl vz

Scheiben DIN 134; mit etwas größerem Außendurchmesser; Stahl; verzinkt;

für Schrauben	d1 mm	d2 mm	s mm	 Teile-Nr.
M6	6,4	14,00	1,5	500 L-K41708
M8	8,4	18,00	2	500 L-K41709
M10	10,5	22,00	2,5	500 L-K41710
M12	13	28,00	3	200 L-K41711
M14	15	28,00	3	200 L-K41712
M16	17	34,00	3	200 L-K41713



## Scheiben ISO 7094 Stahl vz

Scheiben ISO 7094; vorwiegend für Holzkonstruktionen; Stahl; verzinkt;

für Schrauben	d1 mm	d2 mm	s mm	Teile-Nr.
M8	9	28,00	3	200 L-K41688
M10	11	34,00	3	200 L-K41689
M12	13,5	44,00	4	200 L-K41690
M16	17,5	56,00	5	100 L-K41691

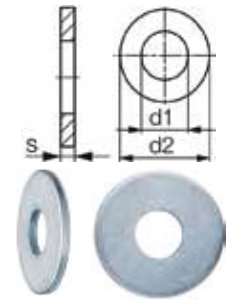

## Scheiben DIN 1052 Stahl vz

Scheiben DIN 1052; vorwiegend für Holzkonstruktionen; Stahl; verzinkt;

für Schrauben	d1 mm	d2 mm	s mm	Teile-Nr.
M12	13	58,00	6	50 L-K41715
M16	19	68,00	6	50 L-K41716
M20	23	80,00	8	25 L-K41717

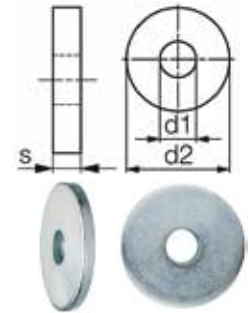

## Kotflügelscheiben Stahl vz

Kotflügelscheiben; dünnere Ausführung; Stahl; verzinkt; für Schrauben / d1 x d2 x s mm;

für Schrauben	Teile-Nr.
M5 / 5,3 x 20 x 1,25 mm	100 L-K41679
M6 / 6,4 x 20 x 1,25 mm	100 L-K41680
M6 / 6,4 x 25 x 1,25 mm	100 L-K41681
M6 / 6,4 x 30 x 1,25 mm	100 L-K41682
M8 / 8,4 x 20 x 1,25 mm	100 L-K41683
M8 / 8,4 x 25 x 1,25 mm	100 L-K41684
M8 / 8,4 x 30 x 1,25 mm	100 L-K41685
M10 / 10,5 x 30 x 1,25 mm	100 L-K41686
M12 / 13 x 40 x 1,25 mm	100 L-K41687



## Scheiben vierkant DIN 436 Stahl vz

Scheiben DIN 436; vorwiegend für Holzkonstruktionen; vierkant; Stahl; verzinkt;

für Schrauben	d1 mm	a mm	s mm	Teile-Nr.
M16	17,5	50,00	5	100 L-K41714



## Federringe DIN 127B Federstahl vz

Federringe DIN 127 B; Enden glatt; Federstahl; verzinkt;

für Schrauben	d1 mm	d2 mm	s mm	Teile-Nr.
M5	5,1	9,20	1,2	100 L-K41672
M6	6,1	11,80	1,6	100 L-K41673
M8	8,1	14,80	2	100 L-K41674
M10	10,2	18,10	2,2	100 L-K41675
M12	12,2	21,10	2,5	100 L-K41676
M16	16,2	27,40	3,5	100 L-K41677
M20	20,2	33,60	4	50 L-K41678



## Optimax: Die neue H-PLUS Faltschachtel bei Ploberger!

NEU



## Rostfreie Verbindungselemente



**NIRO-A2**

### Zylinderschrauben ISK DIN 912 / ISO 4762 Edelstahl A2

Zylinderschrauben DIN 912 ISO 4762; mit Innensechskant; Edelstahl A2; VG: Vollgewinde, TG: Teilgewinde;

Dimension	b mm	s mm	k mm	t mm	dk mm		Teile-Nr.
<b>M4</b>							
M4 x 10 VG	0,00	3	4,00	2,00	7,00	200	L-K41752
M4 x 16 VG	0,00	3	4,00	2,00	7,00	200	L-K41753
M4 x 20 VG	0,00	3	4,00	2,00	7,00	200	L-K41754
M4 x 25 VG	0,00	3	4,00	2,00	7,00	200	L-K41755
<b>M5</b>							
M5 x 10 VG	0,00	4	5,00	2,50	8,50	100	L-K41756
M5 x 12 VG	0,00	4	5,00	2,50	8,50	100	L-K41757
M5 x 16 VG	0,00	4	5,00	2,50	8,50	100	L-K41758
M5 x 20 VG	0,00	4	5,00	2,50	8,50	100	L-K41759
<b>M6</b>							
M6 x 10 VG	0,00	5	6,00	3,00	10,00	100	L-K41760
M6 x 12 VG	0,00	5	6,00	3,00	10,00	100	L-K41761
M6 x 16 VG	0,00	5	6,00	3,00	10,00	100	L-K41762
M6 x 20 VG	0,00	5	6,00	3,00	10,00	100	L-K41763
M6 x 25 VG	0,00	5	6,00	3,00	10,00	100	L-K41764
M6 x 30 VG	0,00	5	6,00	3,00	10,00	100	L-K41765
M6 x 40 TG	24,00	5	6,00	3,00	10,00	100	L-K41766
<b>M8</b>							
M8 x 16 VG	0,00	6	8,00	4,00	13,00	100	L-K41767
M8 x 20 VG	0,00	6	8,00	4,00	13,00	100	L-K41768
M8 x 25 VG	0,00	6	8,00	4,00	13,00	100	L-K41769
M8 x 30 VG	0,00	6	8,00	4,00	13,00	100	L-K41770
<b>M10</b>							
M10 x 30 VG	0,00	8	10,00	5,00	16,00	100	L-K41771



**NIRO-A2**

### Sechskantschrauben DIN 933 / ISO 4017 Edelstahl A2

Sechskantschrauben DIN 933, ISO 4017; ohne Schaft; Edelstahl A2; VG: Vollgewinde, TG: Teilgewinde;

Dimension	s mm	k mm	e mm	Norm		Teile-Nr.
<b>M6</b>						
M6 x 16 VG	10	4,00	11,05	DIN 933 / ISO 4017	200	L-K41735
M6 x 20 VG	10	4,00	11,05	DIN 933 / ISO 4017	200	L-K41736
M6 x 25 VG	10	4,00	11,05	DIN 933 / ISO 4017	200	L-K41737
M6 x 30 VG	10	4,00	11,05	DIN 933 / ISO 4017	200	L-K41738
<b>M8</b>						
M8 x 16 VG	13	5,30	14,38	DIN 933 / ISO 4017	100	L-K41739
M8 x 20 VG	13	5,30	14,38	DIN 933 / ISO 4017	100	L-K41740
M8 x 25 VG	13	5,30	14,38	DIN 933 / ISO 4017	100	L-K41741
M8 x 30 VG	13	5,30	14,38	DIN 933 / ISO 4017	100	L-K41742
<b>M10</b>						
M10 x 20 VG	16	6,40	17,77	ISO 4017	100	L-K41743
M10 x 25 VG	16	6,40	17,77	ISO 4017	100	L-K41744
M10 x 30 VG	16	6,40	17,77	ISO 4017	100	L-K41745
M10 x 40 VG	16	6,40	17,77	ISO 4017	100	L-K41746
M10 x 50 VG	16	6,40	17,77	ISO 4017	100	L-K41747
<b>M12</b>						
M12 x 30 VG	18	7,50	20,03	ISO 4017	100	L-K41748
M12 x 40 VG	18	7,50	20,03	ISO 4017	50	L-K41749
M12 x 50 VG	18	7,50	20,03	ISO 4017	50	L-K41750
M12 x 60 VG	18	7,50	20,03	ISO 4017	50	L-K41751

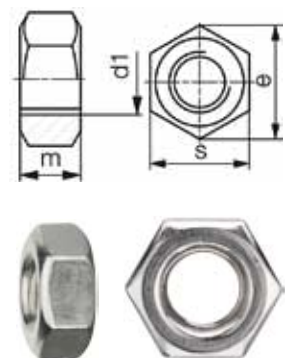

**NIRO-A2**

### Sechskantmuttern DIN 934 Edelstahl A2

Sechskantmuttern schweißbar aus Edelstahl mit Innengewinde nach Norm; DIN 934; Edelstahl A2; Gewinde: Normal;

d1 mm	s mm	m mm	e mm		Teile-Nr.
M6	10	5,00	11,05	500	L-K41729
M8	13	6,50	14,38	500	L-K41730
M10	17	8,00	18,90	200	L-K41731
M12	19	10,00	21,10	200	L-K41732
M14	22	11,00	24,49	50	L-K41733
M16	24	13,00	26,75	50	L-K41734

## Scheiben DIN 125A Edelstahl A2

Scheiben DIN 125A; ohne Fase; Edelstahl A2;

**NIRO-A2**

für Schrauben	d1 mm	d2 mm	s mm	Teile-Nr.
M4	4,3	9,00	0,8	200 L-K41721
M5	5,3	10,00	1,0	200 L-K41722
M6	6,4	12,00	1,6	200 L-K41723
M8	8,4	16,00	1,6	200 L-K41724
M10	10,5	20,00	2	200 L-K41725
M12	13	24,00	2,5	200 L-K41726
M14	15	28,00	2,5	100 L-K41727
M16	17	30,00	3	100 L-K41728

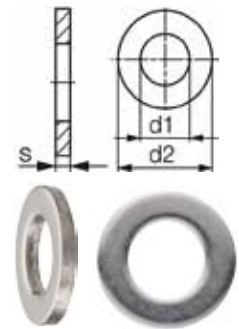

## Holzschrauben

### Sechskant-Holzschrauben DIN 571 Stahl vz

Holzschrauben aus Stahl mit Sechskantkopf; Einsatzbereich: Holzbau; wird als Dübelschraube zur Befestigung von Bauteilen auf Beton verwendet; Stahl, verzinkt;

Dimension mm	s mm	e mm	k mm	Teile-Nr.
<b>6,0 mm</b>				
6 x 40	10,00	10,89	4,00	200 L-E00781
6 x 60	10,00	10,89	4,00	200 L-E00784
6 x 80	10,00	10,89	4,00	200 L-E00786
<b>8,0 mm</b>				
8 x 50	13,00	14,20	5,50	200 L-E00791
8 x 60	13,00	14,20	5,50	200 L-E00792
8 x 70	13,00	14,20	5,50	200 L-E00793
8 x 80	13,00	14,20	5,50	200 L-E00794
8 x 100	13,00	14,20	5,50	100 L-E00796
<b>10 mm</b>				
10 x 80	17,00	18,72	7,00	100 L-E00802
10 x 100	17,00	18,72	7,00	100 L-E00804
10 x 120	17,00	18,72	7,00	50 L-E00805
<b>12 mm</b>				
12 x 70	19,00	20,88	8,00	50 L-E00809
12 x 80	19,00	20,88	8,00	50 L-E00810
12 x 100	19,00	20,88	8,00	50 L-E00812

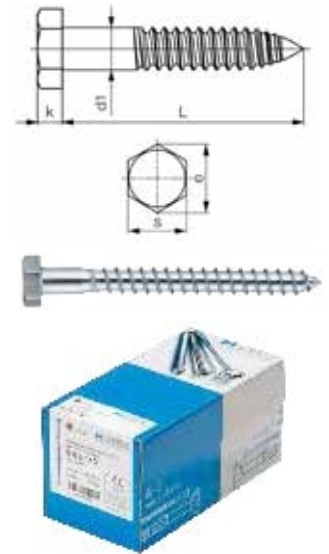

### Holzbauschraube VermoTec Senkkopf TX Stahl vz

Holzschrauben mit Senkkopf und Innensechsrund (TX) als Antrieb sowie Schabenut, Schaftausreiber und Teilgewinde (TG); Schabenut und Fräsrippen sorgen für schnelles und einfaches Einschrauben; kein Schlagen der Schrauben durch TX-Antrieb;

Dimension mm	Größe TX	dk mm	b mm	k mm	Teile-Nr.
<b>4,0 mm</b>					
4 x 60 TG	20	8,00	36,00	4,25	200 L-811282
4 x 70 TG	20	8,00	42,00	4,25	200 L-811285
<b>4,5 mm</b>					
4,5 x 60 TG	25	9,00	36,00	4,65	200 L-811294
4,5 x 70 TG	25	9,00	42,00	4,65	200 L-811300
<b>5,0 mm</b>					
5,0 x 40 TG	25	10,00	24,00	5,05	200 L-811372
5,0 x 50 TG	25	10,00	30,00	5,05	200 L-811374
5,0 x 60 TG	25	10,00	36,00	5,05	200 L-811381
5,0 x 70 TG	25	10,00	42,00	5,05	200 L-811384
5,0 x 80 TG	25	10,00	48,00	5,05	200 L-811385
5,0 x 90 TG	25	10,00	54,00	5,05	200 L-811387
5,0 x 100 TG	25	10,00	60,00	5,05	200 L-811389
5,0 x 120 TG	25	10,00	70,00	5,05	200 L-811390
<b>6,0 mm</b>					
6,0 x 60 TG	30	12,00	36,00	5,90	200 L-811392
6,0 x 80 TG	30	12,00	48,00	5,90	200 L-811396
6,0 x 100 TG	30	12,00	60,00	5,90	100 L-811399
6,0 x 120 TG	30	12,00	70,00	5,90	100 L-811401
6,0 x 140 TG	30	12,00	70,00	5,90	100 L-811403
6,0 x 160 TG	30	12,00	70,00	5,90	100 L-811405
<b>8,0 mm</b>					
8 x 80 TG	40	14,90	48,00	7,50	50 L-811415
8 x 100 TG	40	14,90	60,00	7,50	50 L-811419
8 x 120 TG	40	14,90	80,00	7,50	50 L-811426
8 x 140 TG	40	14,90	80,00	7,50	50 L-811430
8 x 160 TG	40	14,90	80,00	7,50	50 L-811431
8 x 180 TG	40	14,90	80,00	7,50	50 L-811434
8 x 200 TG	40	14,90	100,00	7,50	50 L-811437

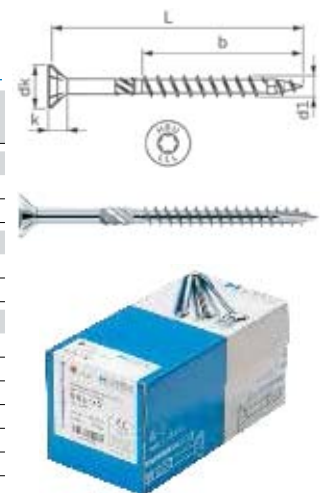

# Jetzt neu: shop.ploberger.net

**PLOBERGER**  
SOLUTIONS FOR PROFESSIONALS

Alle Kategorien

Suchbegriff, ...



Anmelden  
Mein eShop



Warenkorb  
0 / € 0,00



Unser Sortiment  
über 65.000 Artikel



Unternehmen

Branchen

Produkte

Service

Karriere

Kontakt



Übersicht Verbindungselemente Innensechskantschrauben

← Erste Seite Seite 1 2 3 Letzte Seite →

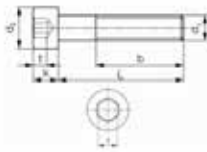

Zylinderschrauben UNC ähnl. DIN  
912 Stahl 12,9 sw

Anmelden und Preise ansehen



Zylinderschrauben UNF ähnl. DIN  
912 Stahl 12,9 sw

Anmelden und Preise ansehen

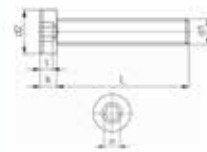

Zylinderschrauben TX ISO 14580  
Stahl 8,8 vz

Anmelden und Preise ansehen

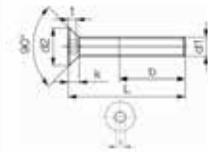

Senkschrauben DIN 7991 / ISO  
10642 Stahl 8,8 sw

Anmelden und Preise ansehen

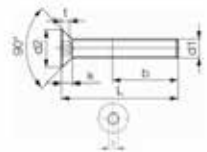

Senkschrauben DIN 7991 / ISO  
10642 Stahl 8,8 vz

Anmelden und Preise ansehen

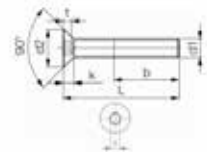

Senkschrauben DIN 7991 / ISO  
10642 Stahl 10,9 sw

Anmelden und Preise ansehen

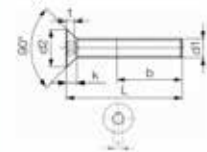

Senkschrauben ISO 10642 Stahl  
10,9 vz

Anmelden und Preise ansehen

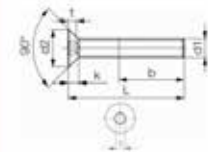

Senkschrauben DIN 7991 / ISO  
10642 Stahl 10,9 zinklamellen

Anmelden und Preise ansehen

## mehr als 24.000 Verbindungselemente und Normteile

### Österreich

Ploberger GesmbH  
Im Stadtfeld 4  
A-2070 Retz

Tel.: +43 / 2942 / 3471-0  
Fax: +43 / 2942 / 3471-1039

office@ploberger.net  
www.ploberger.net

### Tschechien

Ploberger s.r.o.  
Hakenova 31  
CZ-669 02 Znojmo

Tel.: +420 / 515 / 267 367  
Fax: +420 / 515 / 267 366

office@ploberger.cz  
www.ploberger.cz

### Slowakei

Ploberger-SK s.r.o.  
Priemyselná 1  
SK-909 01 Skalica

Tel.: +421 / 346 / 941 271  
Fax: +421 / 346 / 941 270

office@ploberger.sk  
www.ploberger.sk

**PLOBERGER**  
SOLUTIONS FOR PROFESSIONALS